

# LAMP® HG-KNT LIFT-OFF TORQUE HINGE Installation Manual

Video Link



Thank you for selecting our product. Before starting installation, please read this manual thoroughly to ensure correct installation.

Please keep this manual at hand for future reference.

## ABOUT THE PRODUCT

- Torque hinge for swing door, suitable for wide range of equipment (OA,FA,physical and chemical,automatic equipment).
- Detachable feature enables easy dismounting of door.

## FOR YOUR SAFE WORK AND CORRECT INSTALLATION

### Meaning of symbols



**⚠ Caution: If these cautions are not followed, it may result in injury or damage.**

- ❗ Do not apply eccentric load on the hinges.
- ❗ Use two hinges per door and align the axis of both hinges.
- ⊘ Indicated torque in SPECIFICATION shows the value at the time of shipment. It may vary after using.
- ⊘ This product is for indoor use only. Do not use outside or anywhere where it will be exposed to water.
- ⊘ While the hinges can be mounted horizontally, you need to mount the hinges in the face to face position to prevent the lid from dropping off. This means you need to give up the feature of detachability.
- ⊘ Do not open/close the hinges repeatedly.

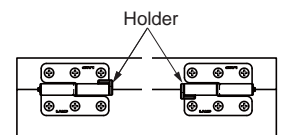
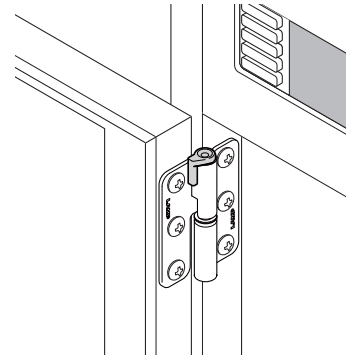

## DIMENSIONS

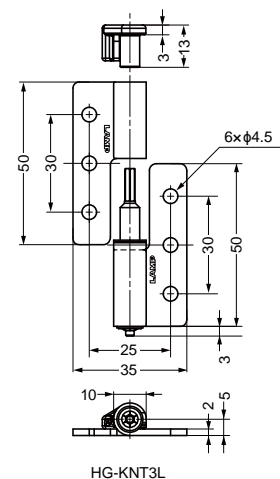
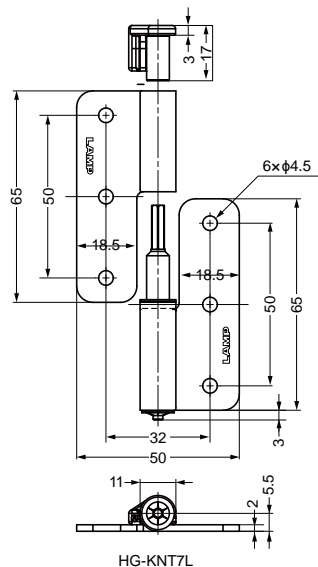
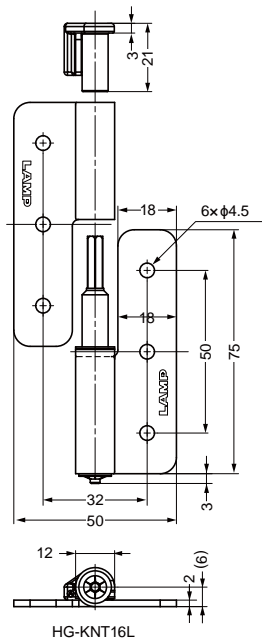

## SPECIFICATIONS

Item Code	Part No.	Hand	Torque (N·m/pc)	Torque (Kgf·cm/pc)
170-035-380	HG-KNT3L	Left handed	0.3±0.2	3.1±2.0
170-035-381	HG-KNT3R	Right handed		
170-035-382	HG-KNT7L	Left handed	0.7±0.25	7.1±2.6
170-035-383	HG-KNT7R	Right handed		
170-035-384	HG-KNT16L	Left handed	1.6±0.3	16.3±3.1
170-035-385	HG-KNT16R	Right handed		

## WHEN USING FOR LID

### 1 Lid Torque Calculation

Moment of lid = Horizontal distance from hinge center to center of gravity x Weight of lid

Max. moment of lid = Max. horizontal distance from hinge center to center of gravity x Weight of lid

### 2 Relationship between lid torque and hinge torque

- Hinges suite the application when the torque of the hinges exceeds the max. moment of the lid.

\*Moment of the lid varies by the opening angle.

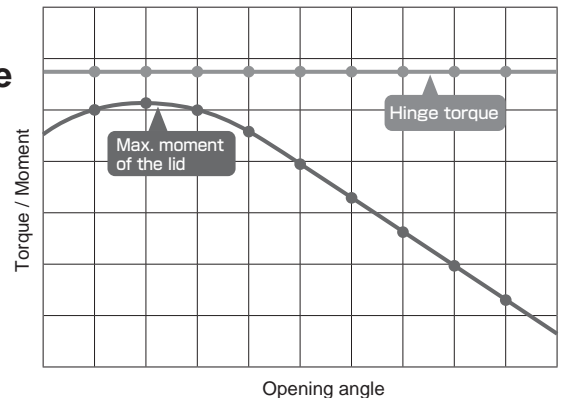

## INSTALLATION PROCEDURE

### 1 Mounting Hinges

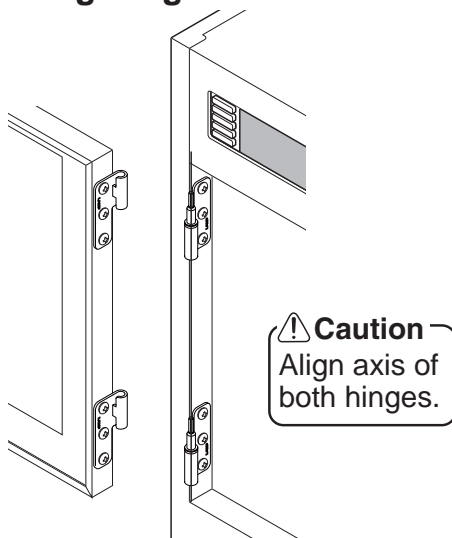

### 2 Hanging Door

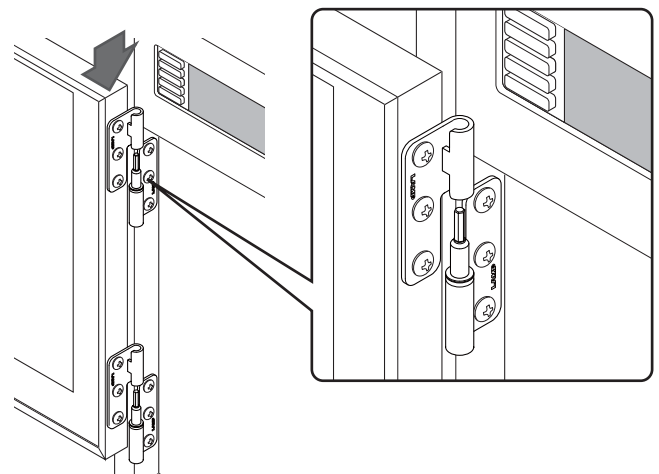

### 3 Inserting Holder

While open/close the door, fit the hole of holder to the hexagonal shaft of hinge.

Do not force to insert the holder. This may result in damage.

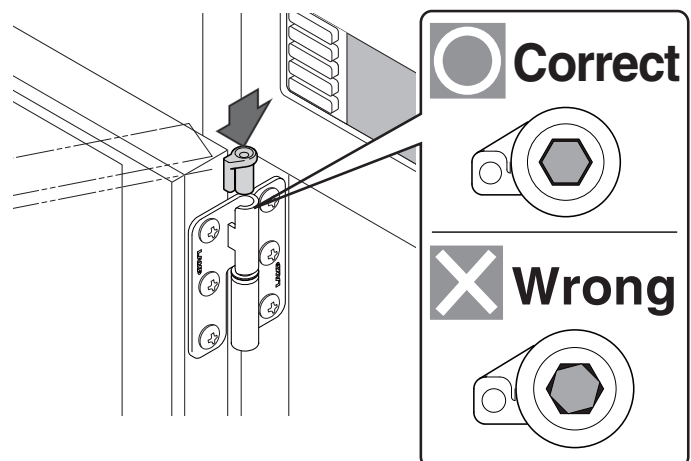

**SUGATSUNE KOGYO CO., LTD**  
Tokyo, JAPAN

Phone: +81 (0)3 3866 2260 E-mail:export@sugatsune.co.jp

**SUGATSUNE KOGYO (UK) LTD**

Reading, UK  
Phone: +44 118 9272 955 E-mail:sales@sugatsune.co.uk

**SUGATSUNE EUROPE GmbH**  
Düsseldorf, GERMANY  
Phone: +49 211 53812900 E-mail:sales@sugatsune.eu

**SUGATSUNE SHANGHAI Co., LTD**  
Shanghai, CHINA

Phone: +86 21 3632 1858 E-mail:lamp@sugatsune.com.cn

**Guangzhou, CHINA**

Phone: +86 20 6639 3552 E-mail:lamp@sugatsune.com.cn

**SUGATSUNE KOGYO INDIA PRIVATE LIMITED**  
Mumbai, INDIA  
Phone: +91 22 28314490/91 E-mail:sales@sugatsune.in

**SUGATSUNE AMERICA, INC**  
California, USA

Phone: +1 310 329 6373 E-mail:sales@sugatsune.com

**Chicago, USA**

Phone: +1 312 461 1081 E-mail:chicagoshowroom@sugatsune.com.

**SUGATSUNE CANADA, INC.**  
Phone: +1 514 312 5267 E-mail:support@sugatsune.ca

ISO9001(Japan Offices and Sugatsune America) and ISO14001(Chiba Production division and Logistics center), certified.

2017.04 1079-1