

製品内容 Parts List

取付寸法図 Installation Drawing

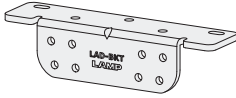

ブラケット : 1 個  
Bracket : 1 pc



バンド小ねじ : 4 本  
Binding head screw : 4 pcs  
(M4×8)



バンドタッピングねじ : 1 本  
Bind tapping screw : 1 pc  
(4.0×16)

※ LAD 本体に付属されているねじ (8 本) も併せてご使用ください。  
※ Use together with the 8 screws included in the LAD body.



取扱説明書 (本書) : 1 枚  
Installation manual : 1 pc

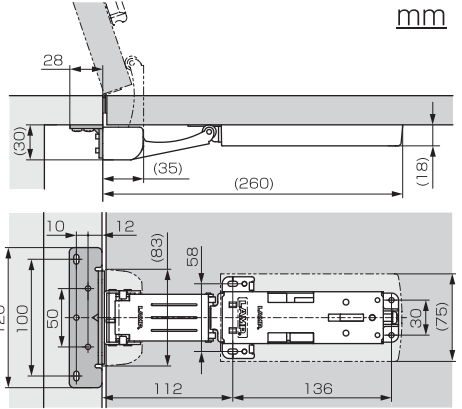

取付手順 Installation Procedure

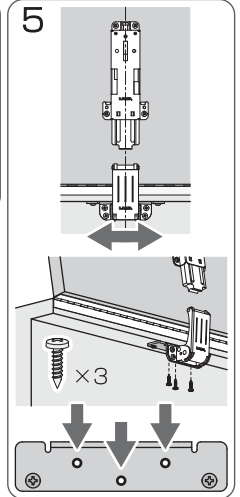
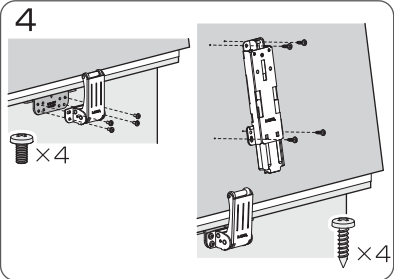
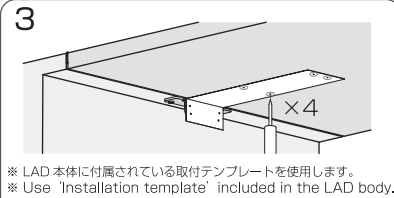
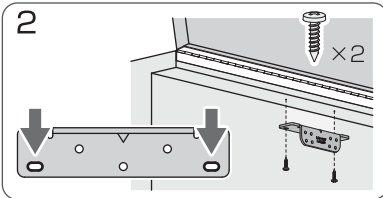
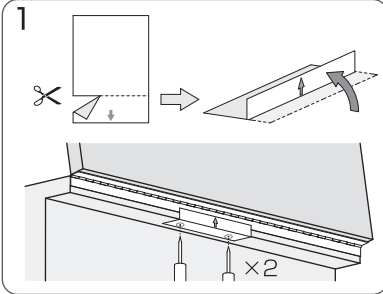

速度調整、カバーの取付手順、取扱上のご注意 及び お問い合わせ先は、『LAD リフトアシストダンパー 取扱説明書』をご覧ください。  
As for Speed Adjustment, Installation of Cover, Safety precautions, or Contact Information, refer to the Instruction for LAD Lift Assist Damper.

2014.05 PRINTED IN JAPAN 0830-1

